

# ECO PRO

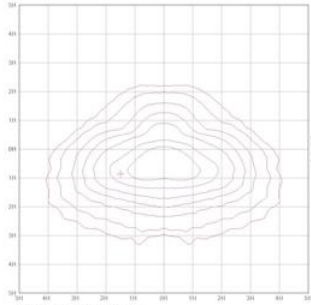

## Základní optiky



M1

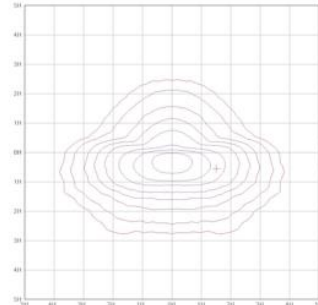

M2

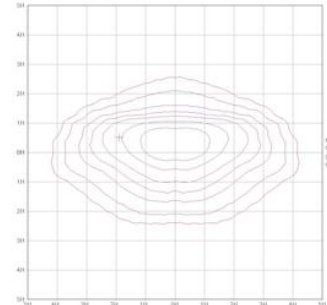

M3

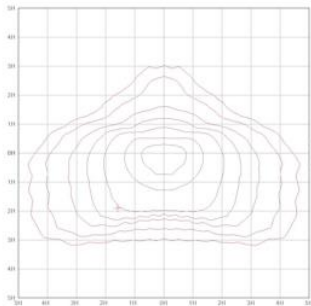

M5

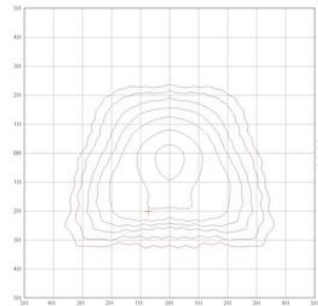

M6

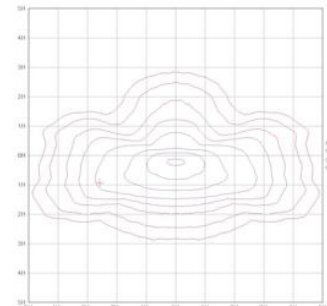

P4

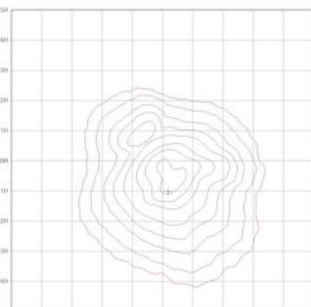

PL

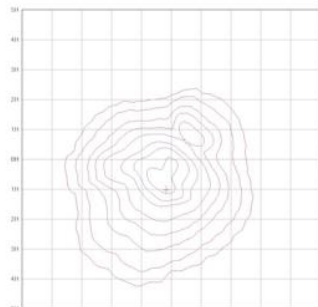

PR

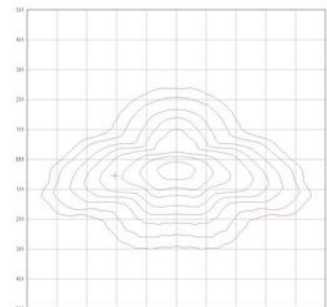

R3

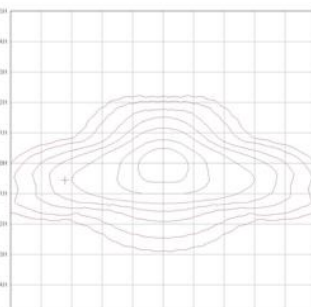

T1

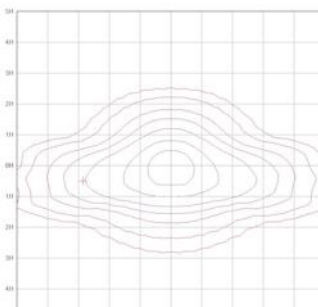

T1A

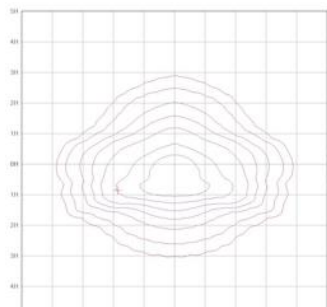

T2

# ECO PRO

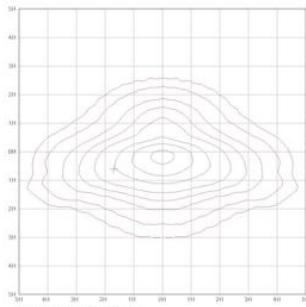

T2A

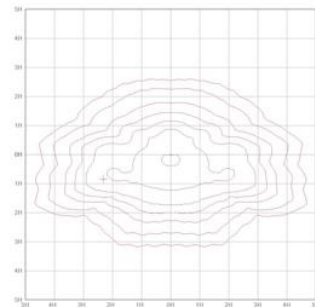

T2C

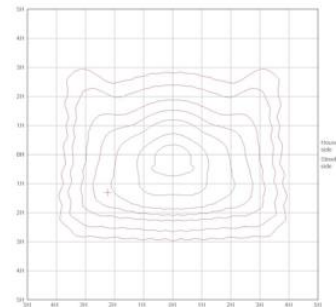

T3

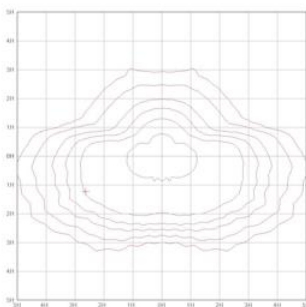

T3B

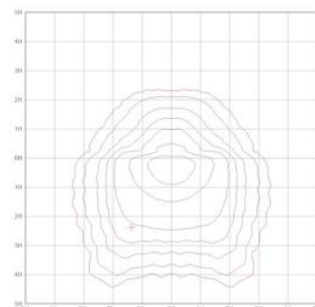

T4

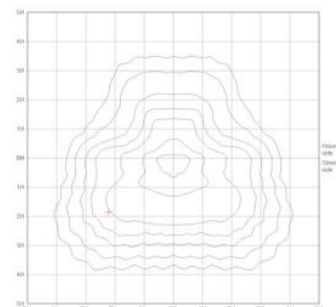

T4B

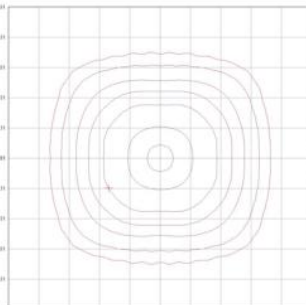

T5

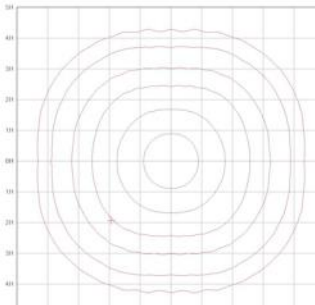

T5B

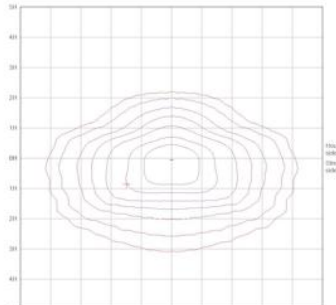

VERB

Teplota okolního prostředí 25 °C. Tolerance elektrických a optických parametrů ±7%. Pro dosažení požadovaných parametrů osvětlenosti pro různé projekty nás kontaktujte za účelem vypracování světelně technického výpočtu. Veškeré produkty podléhají neustálému vývoji. Dodavatele si vyhrazuje právo na změnu parametrů bez předchozího upozornění. Aktuální údaje získáte u Vašeho dodavatele.

## Clona pro omezení oslnění BLC-001



Příslušenství

# ECO PRO



## OPTIKY AMBER AMBER-XXX



Dle projektu, na zakázku